

| DIMENSION | TOLERANCE |
|-----------|-----------|
| ≤ 10 | ± 0.3 |
| 10~100 | ± 0.5 |
| ≥ 100 | ± 0.8 |

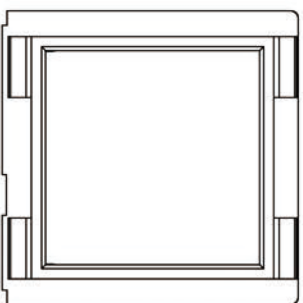
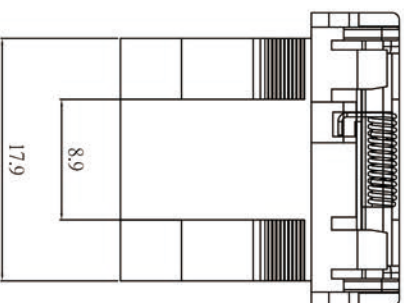
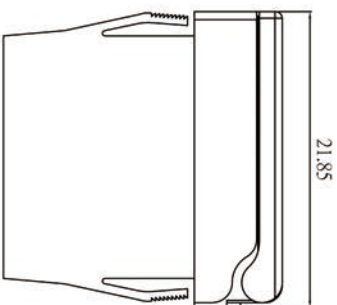
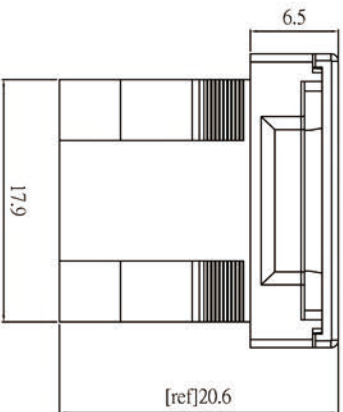
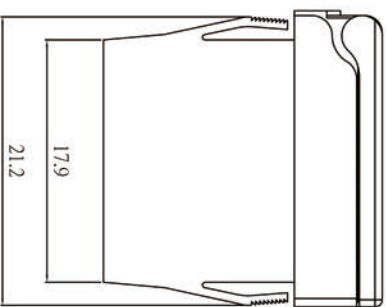
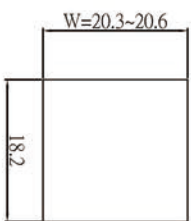
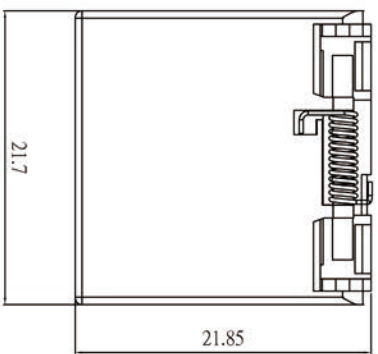
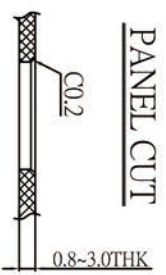

"AUTO RESET"

| | | | | | | | | | |
|------|-----------|----------|---------|------|------|--------------------------------|-----------------|----------------------|-------|
| VER | | | | | | | | | |
| DATE | 2016/1/20 | APPROVAL | JOHNSON | ALEN | MIKE | ENGINEERING RECORD DESCRIPTION | ORIGINAL DESIGN | UNIT | mm |
| | | CONFIRM | | | | | | SCALE | 1 : 1 |
| | | | | | | | | ANGLE TIR | ± 3° |
| | | | | | | | | VIEW | |
| | | | | | | | | PUSH WITH LED SWITCH | |
| | | | | | | | | MODE | |
| | | | | | | | | PLB+PKT | |
| | | | | | | | | Tel: | |

WWW.SLAKEVIEW.COM
ELECTRONICS CO., LTD