

DIMENSION	TOLERANCE
BELOW 10 mm	± 0.25
10~50 mm	± 0.4
ABOVE 50 mm	± 0.7

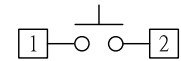

SW CIRCUIT

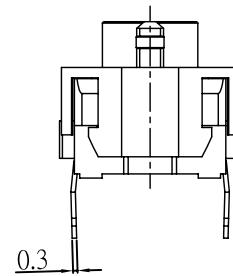

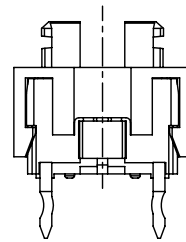
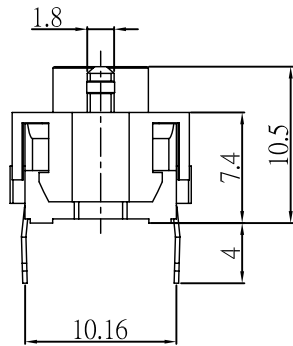
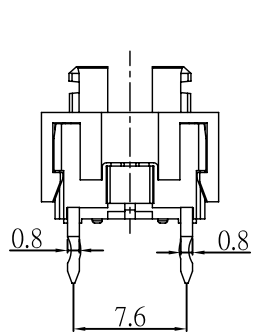
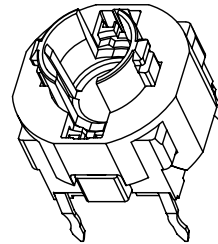
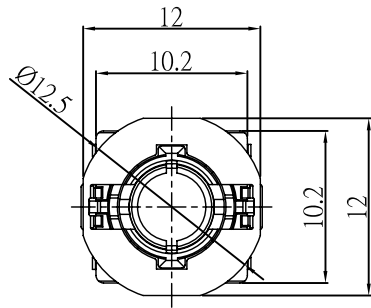
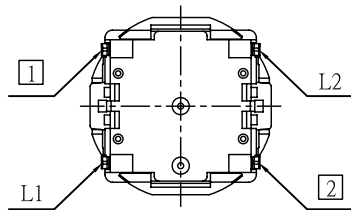

SPECIFICATION :

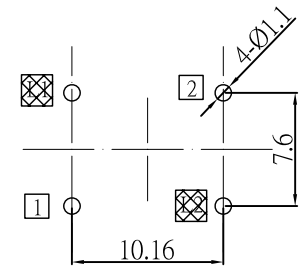
1. RATING : 12 VDC,50mA
2. CONTACT RESISTANCE : 100mΩ MAX(INITIAL)
3. INSULATION RESISTANCE:100MΩ MIN
4. BREAKDOWN VOLTAGE : 500 VAC FOR 1 MINUTE
5. OPERATING FORCE : 280±80gf
6. TOTAL TRAVEL : 0.85±0.3mm
7. OPERATING TEMPERATURE: -20°C ~ 70°C
8. LIFE CYCLE : 1,000,000 CYCLE



PCB LAYOUT

						UNIT	mm	MODE	TACT WITH LED SWITCH	 WWW.SZLAKEVIEW.COM ELECTRONICS CO., LTD	
V0	2015/7/25	JOHNSON	ALEN	MIKE	ORIGINAL DESIGN	SCALE	1 : 1	ANGLE TER	± 3°		
VER	DATE	APPROVAL	CONFIRM	DESIGN	ENGINEERING RECORD DESCRIPTION	PART	TL13-AA1NNNN-R1N	VIEW		PHONE	(86)755-29424722/29424733